

heatilator[®]
The first name in fireplaces



Rave Series

direct vent gas fireplaces

Rave Series

direct vent gas fireplaces



Cover: Rave 42 shown with Deco front in black and black glass media.
Above: Rave 32 shown with Illusion front in black and black glass media.

The best-valued landscape fireplace series in the industry.

The Rave Series offers a modern touch for both residential and commercial applications. Available in two sizes, the Rave looks great as is or can be upgraded to customize your space. Featuring black or crystal glass and ceramic fiber stone media options, the Rave Series allows you to mix and match your style. The Illusion and Deco front surround design options available in black or bronze finishes enhance this modern fireplace series and your space.

- The Rave Series provides a modern, landscape option that is value priced to fit in any floor plan
- Looks great as is or upgrade with media options
- Comfortable heat output with 26,000 BTU input in the Rave 42 and 20,000 BTU output in the Rave 32
- Top direct vent system only
- Direct vent system uses only outside air for combustion and vents outside for better indoor air quality and a healthy home
- Utilizes SLP venting components
- WSK-21 wall control included
- Tested and listed to ANSI standards
- Limited Lifetime Warranty*



Our exclusive, state-of-the-art IntelliFire ignition system reduces gas consumption and thermogenerator wear by providing a pilot flame only when needed. It also supplies a back-up battery system to run the fireplace during a power outage.

Options

Fronts



Illusion front
Clean, modern front with convex face and protective mesh. Shown in Black; also available in Bronze.



Deco Front
Clean, modern front with protective mesh. Shown in Black; also available in Bronze.

Front Finishes



Black

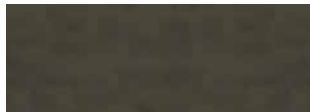

Bronze

Media



Black Glass



Crystal Glass



Ceramic Fiber Stones

Reflective Glass Interior Liner



Available for the Rave 32 only.

Models Available

MODEL	BTU/HR INPUT(NG)	VIEWING AREA	VENTING	IGNITION SYSTEM	FUEL
RAVE4013I	26,000	39-1/16" X 13-1/4" (992mm x 337mm)	Direct Vent	IntelliFire	NG (standard) / LP
RAVE3012I	20,000	27-1/4" X 11-1/2" (692mm x 292mm)	Direct Vent	IntelliFire	NG (standard) / LP

U.S. Efficiencies

Steady State - Since most homeowners use their fireplaces for an extended time while they are in the room, Steady State measures how efficiently your fireplace converts fuel to heat once it is warmed up and running in a "steady state".

AFUE - AFUE rating is more typically used with appliances, like your furnace, that continually cycle on and off to maintain a constant temperature.

Canada Efficiencies

EnerGuide (CSA P.4.1-02) - EnerGuide is a rating used in Canada to measure annual fireplace efficiency.

Rating	RAVE4013I	RAVE3012I
Steady State	75.3% (NG), 75.3% (LP)	60.5% (NG), 65.1% (LP)
AFUE	59.5% (NG), 64.4% (LP)	57.37% (NG), 63.0% (LP)

Rating	RAVE4013I	RAVE3012I
EnerGuide (CSA P.4.1-02)	60.6% (NG), 63.4% (LP)	57.41% (NG), 61.6% (LP)

Technical Specifications

MODEL	FRONT WIDTH	BACK WIDTH	HEIGHT	DEPTH	VIEWING AREA
RAVE4013I	48" (1218mm)	37-3/4" (959mm)	41-3/4" (1060mm)	16-3/4" (425mm)	39-1/16" X 13-1/4" (993mm x 337mm)
RAVE3012I	36-3/4" (933mm)	25-3/4" (654mm)	36" (914mm)	18-5/16" (465mm)	27-1/4" X 11-1/2" (692mm x 292mm)

RAVE4013I Dimensions

Top View

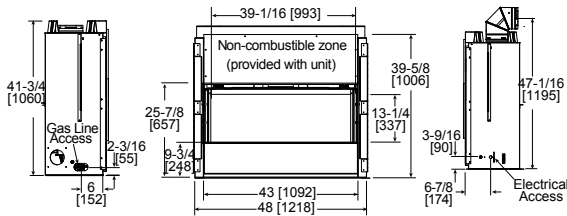
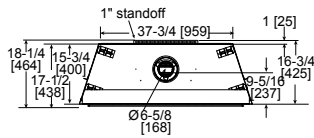

Left Side View

Front View

Right Side View

RAVE3012I Dimensions

Top View

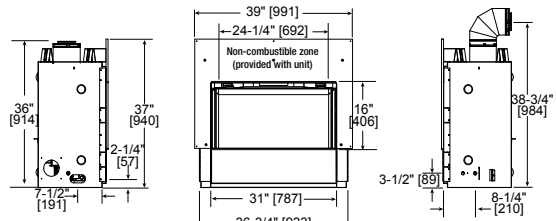
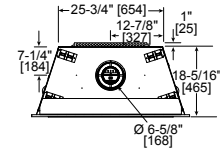

Left Side View

Front View

Right Side View

Clearances

MODEL	A	B	C	D	E	F
RAVE4013I	53-1/2" (1347mm)	48" (1218mm)	75" (1905mm)	See install manual for mantel & wall projections	19-9/32" (490mm)	17-3/4" (451mm)
RAVE3012I	46-3/4" (1188mm)	37-3/4" (959mm)	63-1/8" (1603mm)		15-1/16" (383mm)	18-3/4" (476mm)

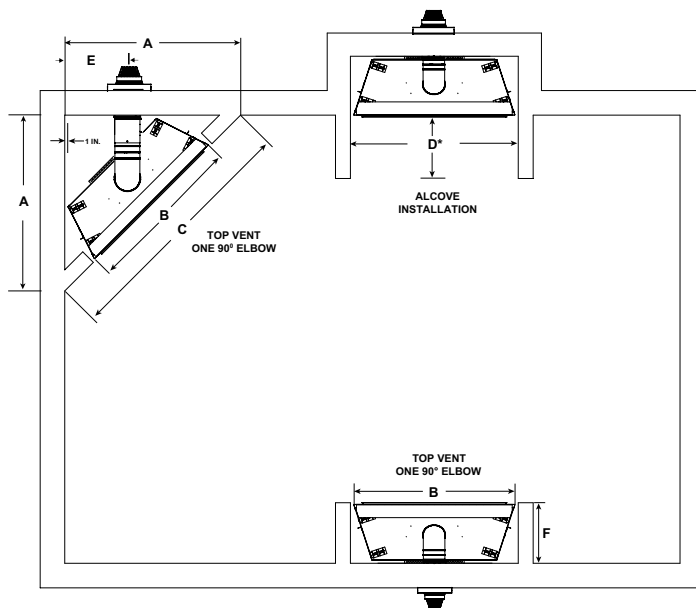

Framing

MODEL	A ROUGH OPEN- ING (WIDTH)	B ROUGH OPEN- ING (HEIGHT)	C ROUGH OPEN- ING (DEPTH)	D ROUGH OPEN- ING (WIDTH)	E CLEARANCE TO CEILING
RAVE4013I	8-5/8" (219mm)	42-1/4" (1073mm)	18-1/4" (464mm)	50" (1270mm)	31" (787mm)
RAVE3012I	8-5/8" (219mm)	36-1/2" (927mm)	18-1/4" (464mm)	37-3/4" (959mm)	31" (787mm)

MODEL	F COMBUSTIBLE FLOOR	G COMBUSTIBLE FLOORING	H BEHIND APPLIANCE	I SIDES OF APPLIANCE	J FRONT OF APPLIANCE
RAVE4013I	0" (0mm)	0" (0mm)	1" (25mm)	1" (25mm)	36" (914mm)
RAVE3012I	0" (0mm)	0" (0mm)	1" (25mm)	1/2" (13mm)	36" (914mm)

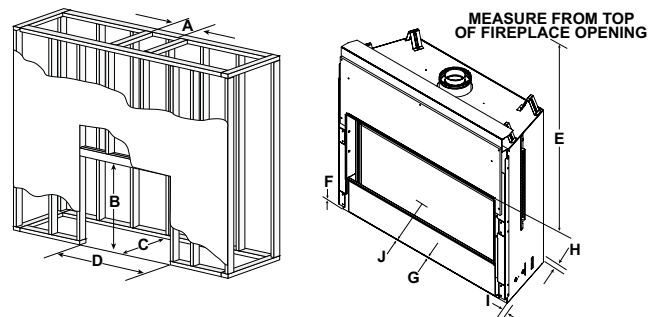

The rough framing dimensions shown represent the distance from stud to stud only and do not take into consideration the addition of drywall. Please refer to installation instructions for complete specifications and drawings when installing this product. Go to heatilator.com to download.

Available From

heatilator
The first name in fireplaces

a brand of
Hearth & Home Technologies Inc.®

1915 West Saunders Street
Mt. Pleasant, Iowa 52641
800-927-6841 | heatilator.com

[facebook.com/Heatilator](https://www.facebook.com/Heatilator)
twitter.com/Heatilator
[youtube.com/HeatilatorFireplaces](https://www.youtube.com/HeatilatorFireplaces)

HTL-1064U-0811

Limited Lifetime Warranty*

The strongest in the industry, Heatilator provides a limited lifetime warranty on gas-burning products of the most important aspects: firebox and heat exchanger.

The information provided in this literature is for planning purposes only and subject to change. Please consult the installation manual for actual installation. Actual product appearance may differ from product images. *For full warranty details go to heatilator.com.

Canada

ENERGUIDE

Look for the **EnerGuide**
Gas Fireplace Energy
Efficiency Rating in this brochure

Based on CSA P.4.1-02

